

TRIPLETT

Model 9045

**True RMS
Digital Multimeter
Instruction Manual**



 **TRIPLETT**

CONTENTS

	PAGE
1. Introduction	2
2. Safety Rules and Warnings	3 - 8
3. International Symbols	8
4. Product Features	9
5. Specifications	10 - 13
6. Front Panel and LCD Display	13 - 16
7. Measurement Procedures	17 - 20
DC & AC Voltage	20 - 21
DC & AC Current	21 - 23
Resistance	24
Continuity	24
Diode	25
Capacitance	26
Frequency & Duty Cycle	27
Temperature	27
8. Maintenance	28
9. Accessories	31
10. Warranty	32

1: INTRODUCTION



The **Triplet Model 9045** is a 6000 count, autoranging, True RMS, handheld Digital Multimeter with a 61 segment bargraph in its backlit Liquid Crystal Display. At its core is an LSI (Large Scale Integration) integrated circuit which uses dual slope A/D conversion for stability and accuracy. The meter can measure AC and DC Voltage and Current, Resistance, Diode voltage drop, Continuity, Capacitance, Temperature, and Frequency. Defeatable Auto Power Off, Data Hold, REL, and Min-Max Memory features enhance convenience, and Overload protection makes the meter resistant to damage from accidental overloads. The overmolded case adds ruggedness and presents a stylish appearance.

WARNING!!!

This meter is NOT to be used to measure power circuitry exceeding CATEGORY III / 600 Volts (CAT III / 600 Volts). Using this meter on such circuitry could result in damage to the meter and user injury.

2: SAFETY RULES & WARNINGS

- 2.1 Read all instructions in this manual before using this meter. Failure to do so may result in damage to the meter or injury to the user.*
- 2.2 Prior to using the meter in any situation which could result in injury to the user, in order to verify that the meter is functional and producing a valid reading, test the meter on a circuit(s) known to have potentials equivalent to the potential that is to be measured. For example, before using the meter to determine if an AC power line is energized with 120VAC, test the meter on a line known to be energized with 120VAC. Failure to do so may result in damage to the meter or injury to the user.*
- 2.3 Do not use this meter with its case open, or with parts removed. Doing so may damage the meter and/or injure the user.*
- 2.4 When using this meter in schools and workshops, responsible teachers or skilled personnel must control the usage of this meter. Failure to observe this precaution may result in damage to the meter or injury to the user.*
- 2.5 Follow the recommendations of any Trade Organizations or Regulatory Agencies whose scope encompasses the use of this meter. Failure to do so may result in damage to the meter or injury to the user.*
- 2.6 Do not open this meter for maintenance without first disconnecting the test leads from all external circuitry. Failure to observe this precaution may result in damage to the meter or injury to the user.*
- 2.7 Repairs and maintenance must only be carried out by qualified service personnel or qualified electricians / technicians who know the dangers of, and the safety rules applicable to this type of equipment. Failure to observe this precaution may result in damage to the meter or injury to the user.*
- 2.8 Always set the meter to the appropriate range or mode before connecting it to the circuitry to be tested. Failure to observe this precaution may result in damage to the meter or injury to the user.*
- 2.9 Check the condition of the test leads before making a measurement. Do not use the test leads if there is damaged insulation or exposed metal. Failure to observe this precaution may result in damage to the meter or injury to the user.*

- 2.10** Make sure test leads are properly inserted and seated in the meter's input jacks. A loose test lead may cause the user to believe that no hazard exists, when in fact, dangerous voltages or currents may be present. Failure to observe this precaution may result in damage to the meter or injury to the user.
- 2.11** Do not touch the tips of the test leads when making a measurement. Do not touch live circuitry when making a measurement. Failure to observe this precaution may result in damage to the meter or injury to the user.
- 2.12** Before using the meter, examine both the meter and the test leads for damage. Do not use the meter if damage (damaged insulation, exposed metal, cracked case, burnt smell, etc.) is evident. Failure to observe this precaution may result in damage to the meter or injury to the user.
- 2.13** Insert the test leads in the jacks specified in the instructions for performing particular tests. Inserting the test leads in incorrect jacks can damage the meter and/or injure the user.
- 2.14** Do not exceed the maximum voltage or current limitations of the meter (see product specifications). Doing so may damage the meter and/or injure the user.
- 2.15** Do not apply voltage or current to the input of the meter when it is set to any of the Ohms Ω ranges. Doing so may damage the meter and/or injure the user.
- 2.16** Do not apply voltage or current to the input of the meter when it is set to the Diode Test  or Continuity Beeper  modes. Doing so may damage the meter and/or injure the user.
- 2.17** Do not attempt to measure a voltage source with the test leads plugged into the meter's $\mu\text{A}/\text{mA}$ or 10A jacks. Doing so may damage the meter and/or injure the user.
- 2.18** Do not rotate the Function switch with the test leads connected to the circuitry to be tested. Doing so may damage the meter or the circuitry, and/or injure the user.
- 2.19** Replace fuses only with exact or equivalent fuses. Do not "bridge" fuses out of circuit. Failure to observe this precaution may result in damage to the meter or injury to the user.

- 2.20** Do not apply voltages to the input of the meter which are elevated above the earth ground potential by more than 600V AC/DC. Doing so may damage the meter and/or injure the user.
- 2.21** Do not continue to use meter when the “low battery” symbol  is displayed. The displayed reading may be in error and lead the user to believe that no hazard exists, when in fact, dangerous voltages or currents may be present. Failure to observe this precaution may result in damage to the meter or injury to the user.
- 2.22** Use caution when working with voltages above 25 volts AC or 35 volts DC. Such voltages may cause a life threatening electrical shock.
- 2.23** This meter is not for use by children. Failure to observe this precaution may result in damage to the meter or injury to the user.
- 2.24** Do not use this meter to make measurements in adverse environments such as rain, snow, fog, or locations with steam, explosive gases or dusts. Doing so may damage the meter and/or injure the user.
- 2.25** Do not use meter in condensing atmospheres. That is, do not use meter in conditions where ambient temperature and humidity could cause condensation of water inside of meter. Doing so may cause injury to the user.
- 2.26** Do not use the meter if either the meter or the test leads are wet, either from exposure to the weather, or after cleaning the case of the meter. Doing so may cause injury to the user.
- 2.27** Do not attempt immediate use of the meter when bringing it from a cold environment to a warm environment. Condensation of water, inside and outside of the meter, may produce dangerous measuring conditions. Allow the meter to warm to room temperature before using. Failure to observe this precaution may result in damage to the meter or injury to the user.
- 2.28** Do not modify the meter. Changing the design may make the meter unsafe and may result in injury to the user.
- 2.29** Use caution when attempting to evaluate if a dangerous voltage is present. The meter will not read AC voltage if it is set to DC, nor will it read DC if it is set to AC. For example, if the meter is set to measure DC Volts, it will not measure a dangerous AC voltage, even if the probes are inserted into a household AC wall outlet.

- 2.30** *Do not touch the metallic portion of one test lead if the other test lead is connected to a live circuit. The current from the live circuit may pass through the meter and appear on the unconnected test lead. Failure to observe this warning may result in user injury.*
- 2.31** *Do not attempt to use meter when no display is present on LCD. Doing so may damage the meter and/or injure the user.*
- 2.32** *Use caution when measuring circuits containing capacitors. Capacitors can store dangerous or lethal levels of electricity, even when the circuitry which they are in has been disconnected from its power source. Some capacitors could source enough energy to damage the meter and/or injure the user.*
- 2.33** *Use caution when using this meter to measure voltages or currents in industrial applications where High Energy circuitry is used. High Energy circuitry is usually regarded as any circuitry capable of supplying over 4000 watts to a load before a safety device (like a fuse) interrupts the circuit.*
- 2.34** *Do not use this meter to measure current in circuits whose open circuit voltage exceeds the voltage range of the meters' fuses. Failure to observe this precaution may result in damage to the meter or injury to the user.*
- 2.35** *When you use the meter to check a high-voltage circuit, do not try to connect both test leads at once. Instead, clip one probe to the neutral or ground lead of the circuit (usually a bare, green, or white wire in AC wiring circuits) using the insulated slip-on Alligator Clips. Then probe for voltages with the other test lead. This helps prevent you from accidentally touching a hot wire, since you need to concentrate on only one test lead. Failure to observe this precaution may result in damage to the meter or injury to the user.*
- 2.36** *If there is any doubt about the condition of the meter (i.e. safe vs unsafe), remove the meter from service and secure it in a location that will prevent its unintentional use. Failure to observe this precaution may result in damage to the meter or injury to the user.*
- 2.37** *Do not use the meter if it does not appear to work correctly on all ranges and in all modes. Failure to observe this precaution may result in damage to the meter or injury to the user.*
- 2.38** *Do not use the meter if it has undergone long-term storage under unfavorable conditions. Failure to observe this precaution may result in damage to the meter or injury to the user.*

- 2.39** Do not use the meter if it may have been damaged in transport. Failure to observe this precaution may result in damage to the meter or injury to the user.
- 2.40** Always connect one of the meter's alligator clips to the low side of a power circuit first. Never clamp onto a hot wire first, (usually red, black, or blue in AC wiring circuits.) If you clamp onto a hot wire first, and touch the other probe, you could receive a shock. Failure to observe this precaution may result in damage to the meter or injury to the user.
- 2.41** To avoid damage to the meter and possible user injury, disconnect test leads from test points before changing the function/range. Failure to observe this precaution may result in damage to the meter or injury to the user.
- 2.42** Avoid usage near strong magnetic fields (magnets, loudspeakers, transformers, motors, coils, relays, contactors, electromagnets, etc.). The meter may display readings that are in error, causing the user to misinterpret the hazards present. For example, the meter may indicate a low voltage when high voltages are actually present. Failure to observe this precaution may result in damage to the meter or injury to the user.
- 2.43** Avoid usage near strong electrostatic fields (high voltage power lines, televisions, computer monitors, etc.). The meter may display readings that are in error, causing the user to misinterpret the hazards present. For example, the meter may indicate a low voltage when high voltages are actually present. Failure to observe this precaution may result in damage to the meter or injury to the user.
- 2.44** Avoid usage near strong RF fields (radio or television transmitters, walkie talkies, cellular phones, etc.). The meter may display readings that are in error, causing the user to misinterpret the hazards present. For example, the meter may indicate a low voltage when high voltages are actually present. Failure to observe this precaution may result in damage to the meter or injury to the user.
- 2.45** Remove the battery when the meter may be left unused for longer than 1 month. Chemical leakage from the battery could damage the meter, leading to user injury.
- 2.46** Do not use the meter if there is evidence of chemical leakage from the battery. Leakage could damage meter and lead to injury of user.

2.47 Observe whether HOLD function is activated. The meter may not show the presence of dangerous potentials when HOLD is activated. For example, if HOLD is applied when the meter is reading zero, and 120VAC is subsequently applied, the meter will continue to read zero. Failure to observe this precaution may result in damage to the meter or injury to the user.

2.48 Do not attempt to test charged capacitors. Only discharged capacitors may be tested. If you wish to test a capacitor, discharge it using an approved method before connecting it to the meter. **Caution:** Some capacitors can store dangerous lethal charges. Discharging these capacitors can be dangerous unless an approved method is used. Failure to observe this precaution may result in damage to the meter or injury to the user.

2.49 Do not use the thermocouple to measure the temperature of objects that are electrically "live". Failure to observe this precaution may result in damage to the meter or injury to the user.

3: INTERNATIONAL SYMBOLS

The following International Symbols may be used in this manual and on the case of the meter to identify, caution, or warn the user of important product limitations or important operational procedures that must be followed to ensure safe usage of the product.



Low Battery



Ground



See Instruction Manual



AC



DC



Fuse



Double Insulated



Beeper



Diode



AC or DC



Dangerous Voltages



Capacitance

4: PRODUCT FEATURES

- 4.1** *True RMS AC Measurements to 750 Volts*
- 4.2** *6000 Count Resolution*
- 4.3** *61 Segment Bargraph*
- 4.4** *Blue Backlit Display*
- 4.5** *Auto / Manual Ranging*
- 4.6** *DC Voltage Ranges to 1000 Volts*
- 4.7** *AC/DC Current ranges to 10 Amps*
- 4.8** *Resistance Ranges to 60 M Ω*
- 4.9** *Temperature Measurements (F or C display)*
- 4.10** *Capacitance Measurements to 4000uF*
- 4.11** *Frequency Measurements (60Hz displays as "60.00")*
- 4.12** *Diode Test indicates true voltage across diode*
- 4.13** *Continuity Beeper*
- 4.14** *Data HOLD button*
- 4.15** *Defeatable Auto Power Off*
- 4.16** *RELative mode*
- 4.17** *Min / Max Memory mode*
- 4.18** *Fused Current Ranges*
- 4.19** *Overload protection*
- 4.20** *Double Insulated Shock Resistant Overmolded Case with Built-in Stand*
- 4.21** *Safety Designed to Comply with IEC 1010-1 (CE)*
- 4.22** *CAT III / 600V and CAT II / 1000V Rated*
- 4.23** *3 Year Warranty*
- 4.24** *Includes: Safety Test Leads with Screw-On Alligator Clips, Thermocouple Probe and Adaptor, 9 Volt Battery*

5: SPECIFICATIONS

- 5.1 **Display:** 0.8" (20.3mm) high LCD
- 5.2 **Display Resolution:** 6000 counts, 0000 to 5999
- 5.3 **Overrange Indication:** Displays "OL"
- 5.4 **Measurement Rate:** 2 to 3 measurements per second
- 5.5 **Low Battery Annunciator:** 
- 5.6 **Operating Conditions:**
Temperature: 0 to 40 degrees C (32 to 104 degrees F)
Relative Humidity: less than 80%
- 5.7 **Storage Conditions:**
Temperature: -20 to 60 degrees C (-4 to 140 degrees F)
Relative Humidity: less than 90%
- 5.8 **Case Dimensions:** 177 x 93 x 39 mm, (L x W x H)
7.0 x 3.7 x 1.5 inches (L x W x H)
- 5.9 **Weight:** 300 grams, 0.7 lbs. (w/ battery, w/o leads)
- 5.10 **Battery:** 1 standard 9 volt alkaline battery (Triplett PN: 37-48)
- 5.11 **Battery Life:** approx. 100 hours
- 5.12 **Fuse:** 800mA / 250 or 600 volt FAST, 5 x 20mm fuse,
for uA or mA ranges.
Triplett PN: 3207-122 (250V), PN: 3207-131 (600V)
10A / 250 or 600 volt FAST, 1/4" x 1" fuse,
for 10A range.
Triplett PN: 3207-125 (250V), PN 3207-128 (600V)
- 5.13 **Insulation:** Double Insulated (Protection Class II)
- 5.14 **Approvals:** IEC 1010-1 (EN61010-1)
Overvoltage Category (Installation Category)
Category I and II to 1000 volts DC
Category I and II to 750 volts AC
Category III to 600 volts AC/DC
CE: EMC, LVD

Note:

- a) The following accuracy specifications are valid at 23 degrees C, +/- 5 degrees C, Relative Humidity less than 75%
- b) The specifications are in the form " +/- (x % of reading + LSD)" where LSD is "Least Significant Digit".

DC Voltage		
Range	Resolution	Accuracy
600mV	0.1mV	±(0.5% rdg + 5 digits)
6V	1mV	
60V	10mV	
600V	100mV	
1000V	1V	±(0.8% rdg + 5 digits)

 **Input Impedance:** All ranges are 10MΩ except 600mV range is greater than 1000MΩ

Overload Protection: 1000V DC or 750V AC RMS Sine (CAT II)

TRMS AC Voltage		
Range	Resolution	Accuracy
6V	1mV	±(0.8% rdg + 5 digits)
60V	10mV	
600V	100mV	
750V	1V	±(1.2% rdg + 5 digits)

 **Input Impedance:** All ranges are 10MΩ

Frequency: 50Hz to 400Hz

Overload Protection: 1000V DC or 750V AC RMS Sine (CAT II)

Display: True RMS

DC Current		
Range	Resolution	Accuracy
600μA	0.1μA	±(2.0% rdg + 5 digits)
6000μA	1μA	
60mA	10μA	±(1.5% rdg + 5 digits)
600mA	0.1mA	
6A	1mA	±(2.0% rdg + 5 digits)
10A	10mA	

 **Overload Protection:** 800mA / 250V or 600V fuse (below 6A range)
10A / 250V or 600V Fuse for 6A and 10A Ranges

Max. Current Input: 10A for 15 sec each 15 min.

Measuring Voltage Drop: Full range is 300mV.

AC Current		
Range	Resolution	Accuracy
600μA	0.1μA	±(2.5% rdg + 5 digits)
6000μA	1μA	
60mA	10μA	±(2.0% rdg + 5 digits)
600mA	0.1mA	
6A	1mA	±(2.5% rdg + 5 digits)
10A	10mA	

 **Overload Protection:** 800mA/250V or 600V fuse (below 6A range)
10A / 250V or 600V fuse for 6A and 10A ranges

Frequency: 50Hz to 400Hz



Max. Current Input: 10A for 15 sec each 15 min.

Measuring Voltage Drop: Full range is 300mV.

Display: True RMS

Resistance		
Range	Resolution	Accuracy
600Ω	0.1Ω	±(1.0% rdg + 5 digits)
6KΩ	1Ω	
60KΩ	10Ω	
600KΩ	100Ω	
6MΩ	1KΩ	±(2.0% rdg + 5 digits)
60MΩ	10KΩ	

 **Overload Protection:** All ranges 600V DC or AC RMS for less than 10 sec. (CAT I)

Diode Test and Continuity Beeper		
Range	Resolution	Accuracy
	Displays actual diode voltage in Volts	Forward DC current about 1mA Open circuit voltage about 2.8V
	Beeper sounds if Continuity Resistance is less than approx. 120 Ohms	Open circuit voltage about 2.8V

 **Overload Protection:** All ranges 600V DC or AC RMS for less than 10 sec. (CAT I)

Capacitance		
Range	Resolution	Accuracy
40nF *	10pF	±(5.0% rdg + 10 LSD)
400nF *	100pF	
4μF	1nF	±(3.0% rdg + 5 LSD)
40μF	10nF	
400μF	100nF	
4000μF	1μF	±(20.0% rdg + 20 LSD)

 **Overload Protection:** 600V DC or AC RMS for 30 sec. max (CAT I)
REL residual zero reading
* Not accurate below 10nF.

Frequency		
Range	Resolution	Accuracy
9.999Hz	0.001Hz	±(0.1% rdg + 5 LSD)
99.99Hz	0.01Hz	
999.9Hz	0.1Hz	
9.999KHz	0.001KHz	
99.99KHz	0.01KHz	
999.9KHz	0.1KHz	
9.999MHz	0.001MHz	

 **Overload Protection:** 600V DC or AC RMS (CAT I)
Input Sensitivity: 1.5V RMS below 100KHz, 5V RMS above 100KHz

Temperature		
Range	Resolution	Accuracy
-58° F to 392° F	2 degree Fahrenheit	±(0.75% rdg + 5 digits)
32° F to 104° F		±5° F
392° F to 752° F		±(1.5% rdg + 5 digits)
-50° C to 200° C	1 degree Centigrade	±(0.75% rdg + 3 digits)
0° C to 40° C		±3° C
200° C to 400° C		±(1.5% rdg + 3 digits)

Overload Protection: 600V DC or AC RMS for 30 sec. (CAT I)
 The provided thermocouple is only rated up to 300°F. Above this temperature, the thermocouple will function, but the lead wire may melt or char.

Duty Cycle		
Range	Resolution	Accuracy
0.1 to 99.9%	0.1%	±(2.0% rdg + 5 digits)

Overload Protection: 600V DC or AC RMS (CAT I)

6: 9045 FRONT PANEL AND LCD DISPLAY

- 1) *LCD Display*
- 2) *Test Probe Holders*
- 3) *Data HOLD and Backlight Button*
- 4) *Rotary FUNCTION Selector Switch*
- 5) *Input Jack for Voltage, Resistance, Capacitance, Temperature, Frequency, Diode Test, and Continuity*
- 6) *COMMon Input Jack for all measurements and tests*
- 7) *µA/mA Input Jack for 600uA to 600mA ranges*
- 8) *10A Input Jack for 6A and 10A ranges*
- 9) *RELative button*
- 10) *FUNCTION pushbuttons, SELECT, Hz/DUTY, MAX/MIN, and RANGE*

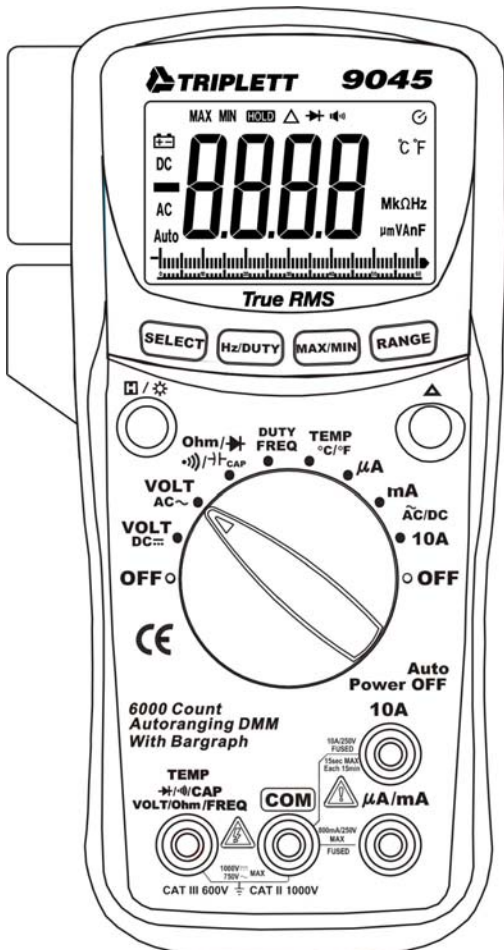

FRONT PANEL OF 9045

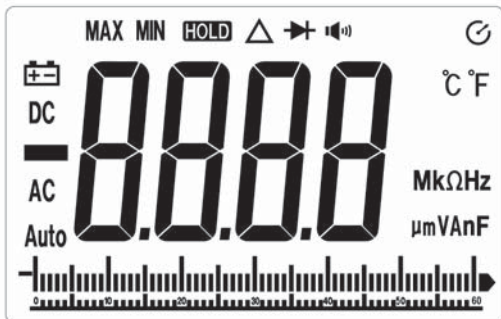

-0000

The numeric digits readout the measured quantity for all modes and functions. The minus sign appears if the measured quantity is negative with respect to the meter's COM jack, or if the meter is REL'ed and the quantity is less than the REL value. Only one decimal point is displayed at a time, its position indicating the range that the meter is set to.

MAX MIN

Either MAX or MIN is displayed when the MAX/MIN mode is activated.

HOLD is displayed when the HOLD mode is activated.

△ is displayed when the REL (sometimes called Delta) mode is activated.

➤ is displayed when the Diode Test mode is activated.

🔊 is displayed when the Continuity Beeper mode is activated.

🔌 is displayed when the Auto Power Off feature is activated.

°C °F

Either C or F is displayed when the Temperature measurement mode is activated.



is displayed when the battery is low.

DC

is displayed when a DC measurement mode is activated, i.e. DC Volts or Amps.

AC

is displayed when an AC measurement mode is activated, i.e. AC Volts or Amps.

Auto

is displayed when the meter is in an Autoranging mode. This is the default mode for the meter. When the user sets the meter to a manual range, the Auto annunciator is turned off.

MkΩHz

A combination of these letters (or symbols) is used to indicate the units of measurement being displayed by the meter. For example, “kHz” (kiloHertz) might be displayed when measuring frequency, or “Ω” might be displayed when measuring resistance.

μmVAnF

A combination of these letters (or symbols) is used to indicate the units of measurement being displayed by the meter. For example, “nF” might be displayed when measuring capacitance, or “V” might be displayed when measuring voltage.

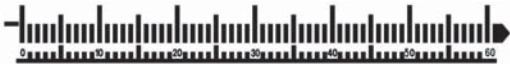

The bargraph visually indicates how the input quantity compares with the measurement range of the meter. For example, if the meter is set to the 6 Volt DC range, and 3 volts is applied to the meter’s input, the bargraph would extend from 0 to 30, half the length of the bargraph, indicating that the measured quantity is 1/2 of the range setting. This feature is often used for “nulling” or “peaking” adjustments, which are easier to visualize on the bargraph, rather than examining the numeric digital reading.

7: MEASUREMENT PROCEDURES

WARNING!!!

Do not use the meter when the low battery annunciator  is displayed. This may cause the meter to produce inaccurate readings, and lead the user to believe that no hazard exists, when, in fact, dangerous voltages or currents are present.

7.1 Pushbuttons and their Functions

7.1.1 Using the HOLD feature

The 9045 incorporates a convenient HOLD feature. This feature “freezes” the reading in the LCD when the  /  button is quickly pressed and released. To release the HOLD, press the button again.

Note: The **HOLD** annunciator appears in the LCD when HOLD is activated.

WARNING!!!

The meter may not show the presence of dangerous potentials when HOLD is activated. For example, if HOLD is applied when the meter is reading zero, and 120VAC is subsequently applied, the meter will continue to read zero. Failure to observe this precaution may result in damage to the meter or injury to the user.

7.1.2 Auto Power Off

The 9045 has Defeatable Auto Power Off. This power saving feature automatically turns the meter off 15 to 20 minutes after the last button press or switch actuation.

The  annunciator appears on the LCD when the feature is activated. To defeat the Auto Power Off, and keep the meter running continuously, hold down the SELECT pushbutton while turning the meter on. The annunciator will not appear in the display.



7.1.3 The SELECT Button

The 9045 has several test functions available on one position of the rotary FUNCTION switch. To access the different functions, the SELECT button is momentarily pressed, repeatedly if necessary, until the desired function is obtained. In the Voltage and Current measurement modes, the SELECT button allows either AC or DC signals to be measured. In the Temperature measurement mode, the SELECT button allows the meter to display its measurement in either Centigrade or Fahrenheit.

On the  position of the rotary FUNCTION switch, use the SELECT button to choose the desired measurement mode.

To determine the measurement mode, observe the LCD display annunciators while the SELECT button is being pressed.

7.1.4 Using the Backlite

The LCD incorporates a blue LED backlite that aids the user when using the meter in poorly lit areas. The same button that activates the HOLD is used to activate the Backlite. To turn on the Backlite, the  /  button is pressed and held for 2 seconds or longer. Because the Backlite consumes so much power (it uses more power than all of the other electronics in the meter), it only stays on briefly (about 8 to 10 seconds) and automatically turns itself off. To turn the Backlite off manually, before it goes off automatically, press and hold the button again until the Backlite turns off.

Since the HOLD feature and Backlite feature share the same button, there is some interaction in their operation. A few presses of the button will reveal how to use the button effectively.

7.1.5 REL Mode

Press the  (REL) button to make subsequent readings RELative to the present reading, or to “zero out” any zero error. The button is usually used to zero out a residual resistance reading on the 600 Ω range, or the residual stray capacitance reading on the 40nF range. This button does not work in all ranges or modes. For example, it doesn't work in the Frequency, Diode Test, or Continuity modes.

7.1.6 MAX / MIN Mode

The 9045 contains a convenient memory that remembers the Maximum and Minimum values measured by the meter. The feature can be used for a few minutes or several hours to memorize the Maximum and Minimum values measured by the meter.

To activate the feature, press the MAX / MIN button when the meter is in the desired range. The MAX annunciator will appear in the display, and the Auto Ranging and Auto Power Off features will deactivate. When the MAX annunciator is displayed, the meter is showing the maximum or “peak” value in its memory. Another press of the MAX / MIN button will turn off the MAX annunciator and turn on the MIN annunciator. Now the minimum or “valley” value in the meter's memory is being displayed. Subsequent presses of the button will toggle the meter's display between the MAX and MIN display modes.

Notes:

This feature does not work in all measurement modes. For example, it does not work in the Frequency, Continuity, Diode Test, and Capacitance modes.

When using MAX / MIN, the meter is in a manual ranging mode... i.e. the meter will not autorange if the signal being measured is above or below the range selected when the MAX / MIN button was pressed.

To return to the normal measurement mode, press and hold the MAX / MIN button until the meter beeps and the MAX and MIN annunciators turn off.

7.1.7 RANGE Selection

After a measurement mode is chosen by using the rotary FUNCTION switch and the SELECT button (if necessary), the RANGE may be chosen manually or automatically. That is, the user has the option to allow the meter to select its measurement range, or the user may manually select the measurement range.

*To allow the meter to select the range, the user need do nothing . . . its automatic. The **Auto** annunciator informs the user that the meter will choose the appropriate measurement range.*

*To select the range manually, press the RANGE button. The first press of the button will turn off the **Auto** annunciator, and the meter will be in the range the meter was on when the Auto annunciator was on. Subsequent presses of the button will manually select additional ranges. The actual range selected can be determined by observing the decimal points and range annunciators on the LCD display.*

Notes:

The ranges are arranged in sequence, starting at the lowest range first, and incrementing to the next higher range with each press of the RANGE button. When on the highest range, the next RANGE button press will set the meter to the lowest range, and each subsequent press will increment the meter to the next higher range.

*To exit the manual ranging mode, press and hold the RANGE button until the meter beeps and the **Auto** annunciator in the display comes on.*

Some modes do not allow the ranges to be selected manually. For example, the Capacitance and Frequency ranges are autoranging only.

7.1.8 Hz / Duty Measurement

Hz (Frequency) and Duty (Duty Cycle) can be measured in two different ways on the 9045. The method chosen depends on the type of measurement being made by the user. The Hz / Duty button is used in both methods. See the following sections for specific information on performing the measurements.

7.2 Rotary FUNCTION Selector Switch

7.2.1 DC Voltage Measurement:



Do not rotate the FUNCTION switch with an input applied to the meter. If the input voltage is higher than 1000V DC (CAT II), or 600V DC (CAT III), do not attempt to measure!



Use Caution when measuring voltages above 50V DC.

7.2.1.1 Connect the black test lead to the **COM** jack and the red test lead to the

TEMP
→/←/CAP jack.
VOLT/Ohm/FREQ

7.2.1.2 Set the rotary FUNCTION switch to the **VOLT DC** position.

7.2.1.3 Connect the test probes to circuit being measured. The LCD will display the DC voltage. Note the position of the decimal point and the units annunciator when reading the voltage.

7.2.1.4 If the display indicates overrange, i.e. "OL", disconnect the test probes from the circuit immediately! The voltage exceeds the measurement range of the 9045.

7.2.1.5 To set the range manually, press the RANGE button, repeatedly if necessary, to select the desired range. Observe the position of the decimal point and the annunciators to identify the selected range.

7.2.2 AC Voltage Measurement



Do not rotate the FUNCTION switch with an input applied to the meter. If the input voltage is higher than 750VAC (CAT II), or 600VAC (CAT III), do not attempt to measure!



Use Caution when measuring voltages above 30V AC.

7.2.2.1 Connect the black test lead to the **COM** jack and the red test lead to the

TEMP
→|/|CAP jack.
VOLT/Ohm/FREQ

7.2.2.2 Set the rotary **FUNCTION** switch to the **VOLT AC~** position.

7.2.2.3 Connect the test probes to circuit being measured. The LCD will display the AC voltage. Note the position of the decimal point and the units annunciator when reading the voltage.

7.2.2.4 If the display indicates overrange, i.e. "OL", disconnect the test probes from the circuit immediately! The voltage exceeds the measurement range of the 9045.

7.2.2.5 To set the range manually, press the **RANGE** button, repeatedly if necessary, to select the desired range. Observe the position of the decimal point and the annunciators to identify the selected range.

7.2.3 DC Current Measurement

WARNING!!!

If the magnitude of the current to be measured is unknown, always start by setting the meter to the highest range, and then to lower ranges, until a satisfactory reading is obtained.

*Do not rotate the **FUNCTION** switch with the input applied to the meter. If the input current is higher than 10A, do not attempt to measure!*



Use caution when measuring current in a circuit with voltages above 50 VDC. Do not use meter to measure current in circuits whose voltage exceeds the voltage rating of the meters' fuses.

7.2.3.1 Connect the black test lead to the **COM** jack. Connect the red test lead to the **10A** jack unless it is known that the input current is less than 600mA or 6000uA. If the current is less than 6000uA or 600mA, connect the red test lead to the **uA/mA** jack.

7.2.3.2 If the red test lead is inserted into the **10A** jack, set the **FUNCTION** switch to the **10A** position. Connect test leads in series with circuit to be measured. Read the value of the current on the LCD display.

7.2.3.3 If the red test lead is inserted into the **uA/mA** jack, set the **FUNCTION** switch to the **uA** or **mA** position. Connect test leads in series with circuit to be measured. Read the value of the current on the LCD.

7.2.3.4 If the display indicates overrange, i.e. "OL", disconnect the test probes from the circuit and reconnect the red test lead to the **10A** jack. Set the **FUNCTION** switch to the **10A** position, and reconnect the test leads to the circuit. Read the value from the LCD. If the input current exceeds the measurement capability of the meter, as evidenced by a display of over 10 amps, or an overrange display, it should not be measured.

7.2.3.5 If the displayed value is less than "600" (decimal point not shown), a more accurate reading may be obtained by setting the **FUNCTION** switch to a lower range and using a different jack. Disconnect the probes from the circuit and rotate the **FUNCTION** switch to the next lower position. Reconnect the test probes to the circuit and observe the reading on the LCD display. If the **FUNCTION** switch is already on the lowest position (i.e. uA), no greater measurement resolution can be obtained.

7.2.3.6 To set the range manually, press the **RANGE** button, repeatedly if necessary, to select the desired range. Observe the position of the decimal point and the annunciators to identify the selected range.

7.2.4 AC Current Measurement:



If the magnitude of the current to be measured is unknown, always start by setting the meter to the highest range, and then to lower ranges, until a satisfactory reading is obtained.

Do not rotate the FUNCTION switch with the input applied to the meter. If the input current is higher than 10A, do not attempt to measure!



Use caution when measuring current in a circuit with voltages above 30 VAC. Do not use meter to measure current in circuits whose voltage exceeds the voltage rating of the meters' fuses.

7.2.4.1 Connect the black test lead to the **COM** jack. Connect the red test lead to the **10A** jack unless it is known that the input current is less than 600mA or 6000uA. If the current is less than 6000uA or 600mA, connect the red test lead to the **uA/mA** jack.

- 7.2.4.2** If the red test lead is inserted into the **10A** jack, set the **FUNCTION** switch to the **10 A** position. Press the **SELECT** button so that the **AC** annunciator is on. Connect test leads in series with circuit to be measured. Read the value of the current on the LCD display.
- 7.2.4.3** If the red test lead is inserted into the **uA/mA** jack, set the **FUNCTION** switch to the **uA** or **mA** position. Press the **SELECT** button so that the **AC** annunciator is on. Connect test leads in series with circuit to be measured. Read the value of the current on the LCD.
- 7.2.4.4** If the display indicates overrange, i.e. "OL", disconnect the test probes from the circuit and reconnect the red test lead to the **10A** jack. Set the **FUNCTION** switch to the **10A** position, and reconnect the test leads to the circuit. Read the value from the LCD. If the input current exceeds the measurement capability of the meter, as evidenced by a display of over 10 amps, or an overrange display, it should not be measured.
- 7.2.4.5** If the displayed value is less than "600" (decimal point not shown), a more accurate reading may be obtained by setting the **FUNCTION** switch to a lower range and using a different jack. Disconnect the probes from the circuit and rotate the **FUNCTION** switch to the next lower position. Reconnect the test probes to the circuit and observe the reading on the LCD display. If the **FUNCTION** switch is already on the lowest position (i.e. **uA**), no greater measurement resolution can be obtained.
- 7.2.4.6** To set the range manually, press the **RANGE** button, repeatedly if necessary, to select the desired range. Observe the position of the decimal point and the annunciators to identify the selected range.

7.2.5 Resistance Measurement





WARNING!!!

Do not apply voltage or current to the meter when the

FUNCTION switch is set to  

7.2.5.1 Connect the black test lead to the **COM** jack, and the red test lead to the

TEMP
 **CAP** jack.
VOLT/Ohm/FREQ

7.2.5.2 Set the FUNCTION switch to the   position. The LCD display will indicate overrange (i.e. "OL").

7.2.5.3 Connect the test leads to the device or circuit being measured. Observe correct polarity if appropriate. Read the value of the resistance on the LCD display.

7.2.5.4 To set the range manually, press the RANGE button, repeatedly if necessary, to select the desired range. Observe the position of the decimal point and the annunciators to identify the selected range.

Notes:

a) The 6M, and 60M ranges may require several seconds to stabilize.

b) To obtain the most accurate reading on the 60 Ω range, short the test leads together and press the REL button to null out any zero error. Unshort the leads and proceed with measurements.

7.2.6 Continuity Beeper



WARNING!!!



Do not apply voltage or current to the meter when the

FUNCTION switch is set to

Ohm  

7.2.6.1 Connect the black test lead to the **COM** jack, and the red test lead to the

TEMP
 **CAP** jack.
VOLT/Ohm/FREQ

7.2.6.2 Set the FUNCTION switch to the  position. Press the SELECT button, repeatedly if necessary, to select the Continuity Beeper mode. The  annunciator will turn on when the Continuity Beeper mode is selected. The LCD display will indicate overrange (i.e. "OL").

7.2.6.3 Connect the test leads to the device or circuit being tested. If the continuity of the tested circuit is less than about 120 Ohms, the beeper will sound and the approximate resistance will be displayed on the LCD.



7.2.7 Diode Test

WARNING!!!

Do not apply voltage or current to the meter when the FUNCTION switch is set to



7.2.7.1 Connect the black test lead to the **COM** jack, and the red test lead to the  jack. 

7.2.7.2 Set the FUNCTION switch to the  position. Press the SELECT button, repeatedly if necessary, to select the Diode Test mode. The  annunciator will turn on when the Diode Test mode is selected.

The LCD display will indicate overrange (i.e. "OL").

7.2.7.3 Connect the test leads to the device or circuit being tested, observing the appropriate polarity. To test a simple diode, connect the red test probe to the Anode of the diode and the black test lead to the Cathode ("banded" end) of the diode. The LCD will indicate the voltage drop of the diode. Reverse the connections of the test probes to the diode. The LCD should indicate overrange ("OL"). If the display reads "0.000 v" when the leads are connected in either direction to a standard silicon diode, the diode is probably shorted.

Note: The reading displayed on the LCD is an accurate indication of the voltage drop of the device or circuit being measured.

7.2.8 Measuring Capacitance

WARNING!!!

**Do not connect a charged capacitor to the meter.
Doing so may damage the meter or injure the user.**

**Do not apply voltage or current to the meter when the
FUNCTION switch is set to**



7.2.8.1 Connect the black test lead to the **COM** jack, and the red test lead to the



7.2.8.2 Set the FUNCTION switch to the  position. Press the SELECT button, repeatedly if necessary, to select the Capacitance Test mode. The nF annunciator will turn on when the Capacitance Test mode is selected.

7.2.8.3 Before testing capacitor, be certain it is discharged and disconnected from any other circuitry that may cause an erroneous measurement.

WARNING!!!

Use an approved method to discharge the capacitor. Some capacitors can hold a dangerous charge, and discharging them inappropriately can be hazardous to the user.

7.2.8.4 When measuring values less than 40nF, consider using the REL feature to “null out” any residual reading. Residual readings of 100 to 150 counts (1.00 to 1.50nF) are typical. Refer to section 7.1.5.

7.2.8.5 Connect the test leads to the capacitor to be tested. Read the measured value from the LCD display.

Note: Capacitors larger than 100uf will take some time to measure. 1000uf will take between 10 and 20 seconds to measure.

If the display indicates OL, the capacitor is larger than the meter will measure, or it is leaky or shorted.

Measurements on capacitors with values less than 10nF are not accurate.

7.2.9 Measuring Temperature

WARNING!!!

Do not attempt to measure the temperature of any surface that is electrically "live". Failure to observe this precaution may result in injury to the user.

Do not apply voltage or current to the meter when the FUNCTION switch is set to

TEMP
°C/°F

7.2.9.1 Remove the test leads from the input jacks of the meter.

7.2.9.2 Set the FUNCTION switch to the **TEMP** position. Using the SELECT button, select the desired units of measurement (C or F). Plug the provided thermocouple adaptor into the **COM** and **TEMP** jacks. The negative side of the adapter (marked "-") plugs into the **COM** jack. Plug the provided thermocouple lead into the adaptor, observing correct polarity (plus to plus, minus to minus).

7.2.9.3 Read the temperature on LCD display. Use the SELECT button to change the units of measure (C or F).

7.2.10 Measuring Frequency and Duty Cycle

Frequency and Duty Cycle can be measured in several different ways on the Triplet 9045. The method chosen depends on the type of measurement being made. For wideband low level measurements, such as measurements in electronic circuitry, the **DUTY FREQ** position on the FUNCTION switch works best. For measurement at higher voltages, and lower frequencies (like 120 VAC /60Hz), the **VOLT AC~** mode works best.

7.2.10.1 'Wideband Low Level Measurements' (several volts peak to peak up to 10MHz) are made by setting the FUNCTION switch to the **DUTY FREQ** position.

7.2.10.2 Connect the black test lead to the **COM** jack, and the red test lead to the

TEMP
→/←/CAP jack.
VOLT/Ohm/FREQ

7.2.10.3 Connect the test leads to the circuit to be measured, and read the frequency on the LCD display. Observe the position of the decimal point and the annunciator to determine the units of measure (i.e. Hz, kHz, MHz, etc)

7.2.10.4 To measure Duty Cycle, press and release the **Hz/DUTY** button. The display will change to a Duty Cycle readout in %. Press the button again to return to the Frequency measurement mode.

7.2.10.5 High Voltage Low Frequency (120VAC, 220VAC, 480VAC, 50Hz, 60Hz) measurements are made in the AC Voltage measurement mode. Set the FUNCTION switch to **VOLT AC~**

7.2.10.6 Connect the black test lead to the **COM** jack, and the red test lead to the **TEMP** jack.



7.2.10.7 Connect the test leads to the circuit to be measured and read the voltage of the signal to be measured.

7.2.10.8 To measure Frequency, press and release the **Hz/DUTY** button. The display will change to a frequency readout. Observe the position of the decimal point and the annunciator to determine the units of measure (i.e. Hz, kHz, etc). Press the button again to measure Duty Cycle in %. Press the button again to return to the AC Voltage measurement mode.

Notes: The **DUTY FREQ** test is very sensitive and is intended to measure low level signals in electronic circuitry. If it is used to measure the frequency of an AC power line, even small amounts of noise or distortion on the line may cause erratic readings.

8: MAINTENANCE

Your Triplet Model 9045 DMM is a precision measuring instrument and, when used as described in this manual, should not require maintenance.

However, periodic calibration of the meter will insure that it is accurate and performing in accordance with its design specifications. A one year calibration interval is suggested.

To clean the outside of the meter, use a cloth dampened with a mild detergent solution. Do not use any abrasive cleansers, or chemical solvents that may damage the case of the meter.

TRIPLETT PRODUCT RETURN INSTRUCTIONS

In the unlikely event that you must return your Triplet equipment for repair, the following steps must be taken.

- 1) Call 1-800-TRIPLETT to obtain a Return Material Authorization (RMA) number from Customer Service.**
- 2) Enclose a copy of the original sales receipt showing date of purchase.**
- 3) Clearly print the RMA number on the outside of the shipping container.**
- 4) Return to:**
Triplet Corporation
One Triplet Drive
Bluffton, OH 45817
ATTN: Repair Dept.

Be sure to include a full description of the problem, and a telephone number, street address, or email address, where you can be contacted, and a return address where the meter can be shipped to upon repair.

8.1 Replacing Battery

8.1.1 *Remove the test leads from the meter.*

8.1.2 *Remove battery cover. Battery installs in the cover. Lift lid (see drawing) and install in cover observing proper polarity.*

8.1.3 *Re-install on meter.*

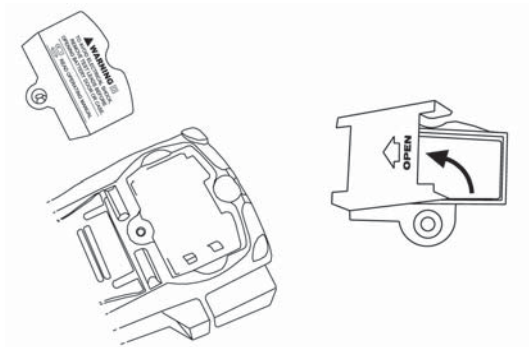

8.2 Replacing Fuse:

8.2.1 Remove the test leads from the meter.

8.2.2 Remove battery cover.

8.2.3 Remove the 3 screws from the back of the meter case. One is behind the stand. See drawing.

8.2.4 Open the meter case by separating the front and back case shells at the bottom of the meter. Gently pull the case apart, and set the back of the case to one side.

8.2.5 Locate the defective fuse and replace with the exact or equivalent type.

See meter specifications.

8.2.6 Reassemble case of meter. Reinstall screws.

8.2.7 Verify that the meter operates properly before using it to make measurements.

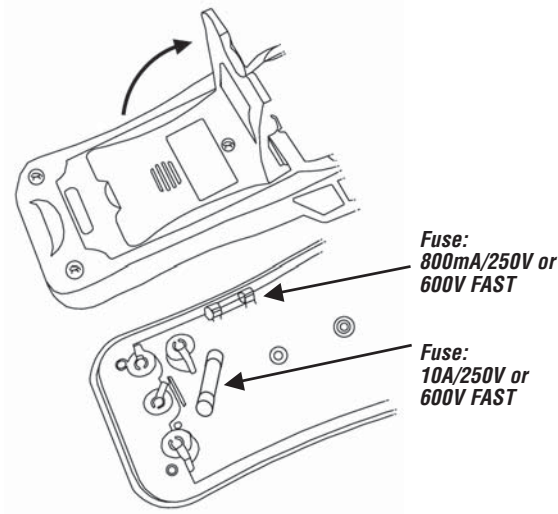

9: ACCESSORIES

9.1 The Triplet Model 9045 package contains the following items:

The Model 9045 DMM

Test leads for the 9045 (Triplet PN: 79-760)

Bead Type Temperature Probe (Triplet PN: 79-761)

Thermocouple Adaptor (Triplet PN: 79-799)

9 Volt Battery (Triplet PN: 37-48)

Instruction Manual (Triplet PN: 84-866)

9.2 Replacement Fuses

800mA / 250V FAST, 5 x 20mm, Triplet PN 3207-122

800mA / 600V FAST, 5 x 20mm, Triplet PN 3207-131

10A / 250V FAST, 1/4" x 1", Triplet PN 3207-125

10A / 600V FAST, 1/4" x 1", Triplet PN 3207-128

9.3 An optional carrying case is available for the 9045. It's constructed of Cordura, with a Velcro secured flap, a belt loop on the back, and a padded interior. (Triplet PN: 10-4275)

10: Triplett Three Year Limited Warranty

The Triplett Corporation warrants instruments and test equipment manufactured by it to be free from defective material or workmanship and agrees to repair or replace such products which, under normal use and service, disclose the defect to be the fault of our manufacturing, with no charge within three years (one year on calibration) of the date of original purchase for parts and labor. If we are unable to repair or replace the product, we will make a refund of the purchase price. Consult the Instruction Manual for instructions regarding the proper use and servicing of instruments and test equipment. Our obligation under this warranty is limited to repairing, replacing, or making refund on any instrument or test equipment which proves to be defective within three years from the date of original purchase.

This warranty does not apply to any of our products which have been repaired or altered by unauthorized persons in any way so as, in our sole judgment, to injure their stability or reliability, or which have been subject to misuse, abuse, misapplication, negligence, accident or which have had the serial numbers altered, defaced, or removed. Accessories, including batteries and fuses, not of our manufacture used with this product are not covered by this warranty.

To register a claim under the provisions of this warranty, contact Triplett Corporation's Customer Service Department for a Return Authorization Number (RMA) and return instructions. **No returned product will be accepted without an RMA number.** Upon our inspection of the product, we will advise you as to the disposition of your claim.

ALL WARRANTIES IMPLIED BY LAW ARE HEREBY LIMITED TO A PERIOD OF THREE YEARS (ONE YEAR ON CALIBRATION) FROM DATE OF PURCHASE, AND THE PROVISIONS OF THE WARRANTY ARE EXPRESSLY IN LIEU OF ANY OTHER WARRANTIES EXPRESSED OR IMPLIED.

The purchaser agrees to assume all liability for any damages and bodily injury which may result from the use or misuse of the product by the purchaser, his employees, or others, and the remedies provided for in this warranty are expressly in lieu of any other liability Triplett Corporation may have, including incidental or consequential damages.

Some states (USA ONLY) do not allow the exclusion or limitation of incidental or consequential damages, so the above limitation or exclusion may not apply to you. No representative of Triplett Corporation or any other person is authorized to extend the liability of Triplett Corporation in connection with the sale of its products beyond the terms hereof.

Triplett Corporation reserves the right to discontinue models at any time, or change specifications, price or design, without notice and without incurring any obligation.

This warranty gives you specific legal rights, and you may have other rights which vary from state to state.