

UQFP Series basic dimensions

All dimensions in inches [Bracketed dimensions in millimeters]

UQFP-4D

TOP VIEW

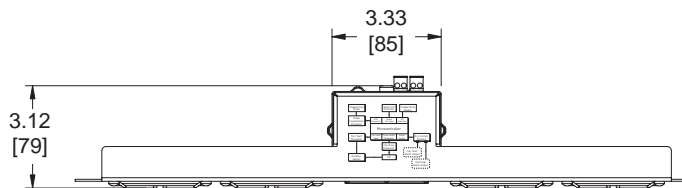

FRONT VIEW

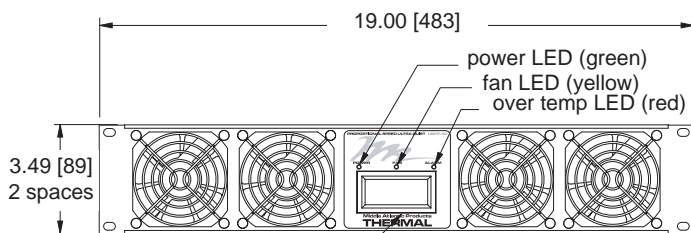

REAR VIEW

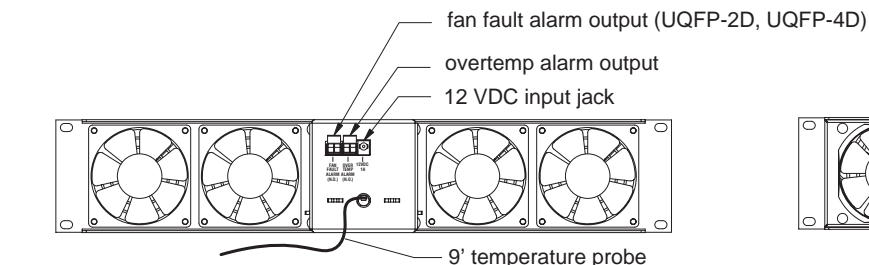

SIDE VIEW

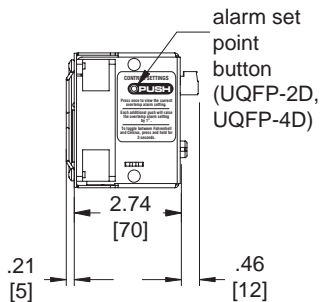

UQFP-4DRx

TOP VIEW

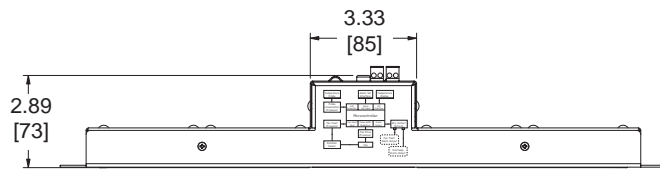

FRONT VIEW

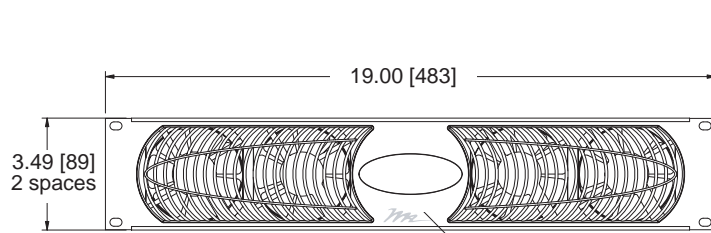

REAR VIEW

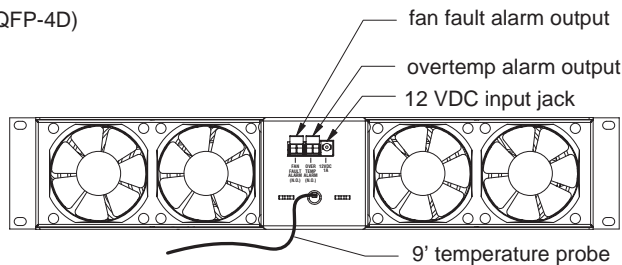

SIDE VIEW

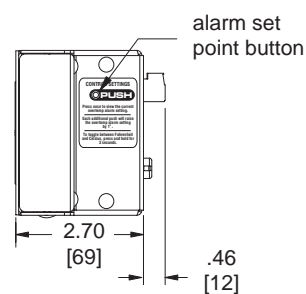

Part #	# of Fans	Overtemp Notification			User Definable Overtemp Setting	Fan Failure Notification Local & Remote Display	Sensor Fault Notification Local	Current Draw at 12 Volts DC	Airflow at Full Speed	dB level at Full Speed	Finish
		Local LED	Local Display	Remote							
UQFP-2D	2	•	•	•	•	•	310 mA	50 CFM	24 dB	Black Powdercoat	
UQFP-4D	4	•	•	•	•	•	560 mA	100 CFM	27 dB	Black Powdercoat	
UQFP-2	2	•		•			270 mA	50 CFM	24 dB	Black Powdercoat	
UQFP-4	4	•		•			510 mA	100 CFM	27 dB	Black Powdercoat	
UQFP-4DRA	4		•	•	•	•	560 mA	100 CFM	27 dB	Black brushed anodized	
UQFP-4DRC	4		•	•	•	•	560 mA	100 CFM	27 dB	Silver brushed anodized	